

# Copper Hood Buying Process.







## 1. Select your model.

### COPPER RANGE HOODS

A handmade copper range hood expertly crafted from the finest materials and according to the highest design standards will do more than simply remove smoke, airborne grease, and lingering odors from your kitchen and dining areas; it will transform your entire kitchen from ordinary to extraordinary!

IDS / COPPER RANGE HOODS

SORT BY: Position 1-12 OF 49 PRODUCTS 1 2 3 4 5

 <p>Signature™ \$2,095.00</p>	 <p>Iron Smith™ \$2,095.00</p>	 <p>Classic™ <del>\$2,295.00</del> \$2,095.00</p>
		

## 2. Select patina & texture.

### Signature™

SKU:1047

**\$2,095.00**

MONEY BACK  
GUARANTEE

FREE  
SHIPPING

PRICE  
MATCH

Shown in: 48"W x 24"D x 42"H - Antique  
Patina, Light Hammered Texture

\* Required Fields

CHOOSE PATINA: DARK ANTIQUE \*



Select Patina

CHOOSE TEXTURE: SMOOTH \*



Select Texture

CHOOSE WIDTH & HEIGHT \*

-- PLEASE SELECT --

### 3. Select height & width.

CHOOSE TEXTURE: \*



CHOOSE WIDTH & HEIGHT \*

Width	Height	Price
36"	21" H	+\$95.00
36"	24" H	+\$195.00
36"	27" H	+\$295.00
36"	30" H	+\$395.00
36"	33" H	+\$495.00
36"	36" H	+\$595.00
36"	39" H	+\$795.00
36"	42" H	+\$895.00
36"	45" H	+\$995.00
36"	48" H	+\$1,195.00
36"	51" H	+\$1,395.00
42"	21" H	+\$295.00
42"	24" H	+\$395.00
42"	27" H	+\$495.00
42"	30" H	+\$595.00
42"	33" H	+\$695.00
42"	36" H	+\$795.00
42"	39" H	+\$895.00
42"	42" H	+\$995.00
42"	45" H	+\$1,095.00

CHOOSE TRADE-WIND™ VENTILATION SYSTEM \*

-- PLEASE SELECT --

Copper Hood should be 30" - 36" above cooktop.

8ft. Ceiling = 24" - 30"  
9ft. Ceiling = 36" - 42"  
10 ft. Ceiling = 48" - 54"

Copper Hood width should be the same width of cooktop or up to 6" larger.

30" Cooktop = 30"- 36" Width  
36" Cooktop = 36"- 42" Width  
42" Cooktop = 42"- 48" Width

### 4. Select Depth & Mount

CHOOSE WIDTH & HEIGHT \*

-- PLEASE SELECT --

CHOOSE MOUNT & DEPTH \*

-- PLEASE SELECT --

-- PLEASE SELECT --

WALL MOUNT (22") STANDARD  
WALL MOUNT (24") +\$95.00  
WALL MOUNT (26") +\$195.00  
ISLAND MOUNT (27" D) +\$295.00  
ISLAND MOUNT (33" D) +\$495.00  
ISLAND MOUNT (36" D) +\$695.00

CHOOSE STRAPS AND RIVETS \*

-- PLEASE SELECT --

CHOOSE TRADE-WIND™ VENTILATION SYSTEM \*

-- PLEASE SELECT --

1 **ADD TO CART**

Need more info width, height and depth?  
[Click here.](#)

## 5. Optional Pot Rail

CHOOSE MOUNT & DEPTH \*

-- PLEASE SELECT --

CHOOSE POT RAIL

-- PLEASE SELECT --

- PLEASE SELECT --
- ANTIQUE COPPER +\$295.00
- BRASS +\$295.00
- DARK ANTIQUE COPPER +\$295.00
- NO POT RAIL
- OIL RUBBED BRONZE +\$295.00
- OLD COIN COPPER +\$295.00
- RAW COPPER +\$295.00
- STAINLESS STEEL +\$295.00

-- PLEASE SELECT --



*\*A pot rail is a optional accessorie for hanging cookware.*

## 6. Straps and rivets

CHOOSE STRAPS AND RIVETS

-- PLEASE SELECT --

- PLEASE SELECT --
- ADD ANTIQUE STRAPS +\$195.00
- ADD ANTIQUE STRAPS & RIVETS +\$225.00
- ADD BRONZE STRAPS +\$195.00
- ADD BRONZE STRAPS & RIVETS +\$225.00
- ADD DARK ANTIQUE STRAPS +\$195.00
- ADD DARK ANTIQUE STRAPS & RIVETS +\$225.00
- ADD OLD COIN STRAPS +\$195.00
- ADD OLD COIN STRAPS & RIVETS +\$225.00
- ADD STAINLESS STEEL STRAPS +\$195.00
- ADD STAINLESS STEEL STRAPS & RIVETS +\$225.00
- NO STRAPS OR RIVETS

TOTAL: \$2,095.00



*\*Straps and rivets are an optional accessorie.*

## 7. Insert Fan

CHOOSE TRADE-WIND™ VENTILATION SYSTEM \*

-- PLEASE SELECT --

-- PLEASE SELECT --

- 30" LINER (NO MOTOR) +\$432.00
- 36" LINER (NO MOTOR) +\$492.00
- 42" LINER (NO MOTOR) +\$535.00
- 48" LINER (NO MOTOR) +\$628.00
- 30" LINER + 390 CFM +\$579.00
- 36" LINER + 390 CFM +\$636.00
- 42" LINER + 390 CFM +\$702.00
- 30" LINER + 660 CFM +\$818.00
- 36" LINER + 660 CFM +\$880.00
- 42" LINER + 660 CFM +\$936.00
- 48" LINER + 660 CFM +\$1,078.00
- 42" LINER + 1360 CFM +\$1,175.00
- 48" LINER + 1360 CFM +\$1,317.00
- 54" LINER + 1360 CFM +\$1,402.00
- JUST THE HOOD

1. Choose the same size liner as your range hood width.

2. Select (no motor) for use with remote blowers.

3. Select (just the hood) if you have your own insert fan. Note: Additional charges may apply and we are not able to accommodate any insert fan. Best to email your insert fan specs to [Info@worldcoppersmith.com](mailto:Info@worldcoppersmith.com) to confirm.

4. Select Liner + CFM for all parts needed to complete installation.

**More questions on insert fans? [Click here.](#)**

## 8. Add to cart & checkout.

CHOOSE STRAPS AND RIVETS

ADD BRONZE STRAPS +\$195.00

CHOOSE TRADE-WIND™ VENTILATION SYSTEM \*

48" LINER (NO MOTOR) +\$628.00

1

ADD TO CART

---

TOTAL: \$3,803.00

f p in g+

## 9. Email confirmation.



### THANK YOU FOR YOUR ORDER FROM COPPERSMITH.

Once your package ships we will send an email with a link to track your order. Your order summary is below. Thank you again for your business.

### Order Questions?

Call Us: [1-888-431-4677](tel:1-888-431-4677)

Email: [info@worldcoppersmith.com](mailto:info@worldcoppersmith.com)

Your order #100000413

Placed on May 3, 2016 12:09:29 PM CDT

Please let us know if you did not receive your email confirmation.

## 10. Final Approval

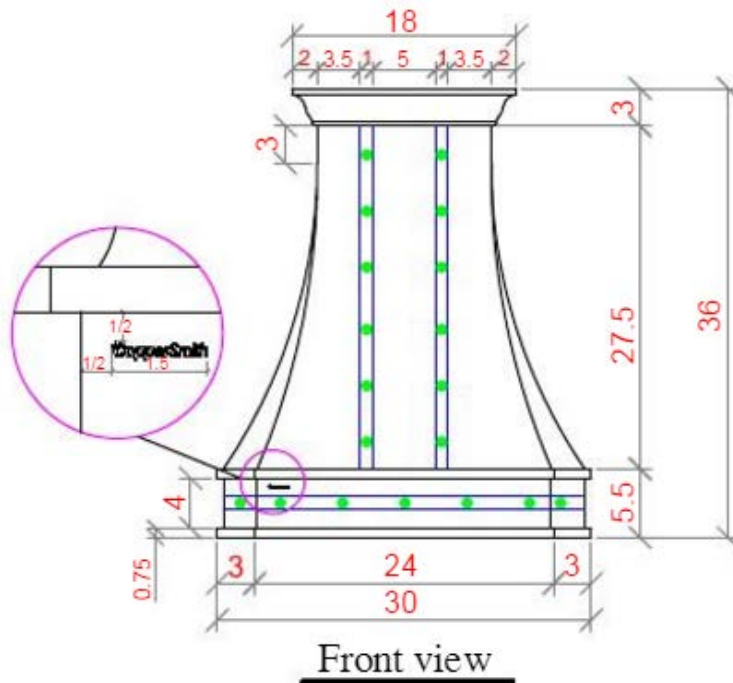

Within 2-5 days of placing the order, we will reach out to confirm your order details and get approval for production. In most cases, we will provide a detailed scaled cad drawing of your range hood. Cad drawings may not be available in for all orders, and additional fees may apply.

## **11. Custom Hood Orders.**

*Not seeing the options you want on website?*

*We do offer custom design services. Here is the info we need to provide a quote:*

- 1. Picture of range hood style & patina.*
- 2. Width, Depth & Height.*
- 3. Shipping address*

***Additional Questions regarding Ordering a Copper Range Hood?***

*Read this: [Everything you need to know about buying a copper range hood.](#)*

*Email us: [Info@worldcoppersmith.com](mailto:Info@worldcoppersmith.com)*

*Call us: 1-888-431-4677*